



**TECNOSERVICE'21 srl**

by Tinti Sergio  
Via Carlo Pisacane, 134  
61032 Fano (PU) Italy  
P.IVA IT0200411413

Tel. +39 0721 805911  
FAX +39 0721 809794  
e-mail: [staff@technochef.it](mailto:staff@technochef.it)  
[www.technochef.it](http://www.technochef.it)  
[www.technochef.eu](http://www.technochef.eu)

Services and Technologies for professional catering since 1973



CODE	DESCRIPTION	PRICE/DELIVERY
<b>SI-KATANA20VV</b>	Horizontal cutter with 20 liter stainless steel tank, continuous inverter speed variator 600/2600 rpm, V. 230/1, Kw.2.39, Weight 93 Kg, dim.mm.820x450x572h	<b>€ 4.222,59</b> <i>VAT excluded</i> <b>Shipping to be calculated</b> <b>Delivery from 4 to 9 days</b>

#### PROFESSIONAL DESCRIPTION

**Horizontal cutter with 20 liter stainless steel tank, Continuous inverter speed variator, 600/2600 rpm :**

- **completely made of AISI 304 stainless steel ;**
- **blades driven by a powerful ventilated asynchronous motor ;**
- **robust AISI 304 stainless steel tank** , removable;
- **stainless steel lid** , with high-resistance food-grade Kepital cap;
- interlocked lid easily removable to facilitate cleaning and sanitization;
- controls with IP 67 stainless steel buttons;
- **easily removable hub with 3 standard blades** (configurable to 2 blades);
- specific blade hubs available for particular processes;
- maximum protection against liquid infiltration on the shaft;
- **ideal for meat , fish and vegetables** but **also suitable for many other processes ;**
- **continuous speed variator managed by inverter ;**
- **three-phase motor powered by 220V inverter ;**
- independent bowl gearmotor.

#### Accessories/Options :

- stainless steel legs with wheels and brake.
- hubs with dull, toothed or blunt blades.

**CE mark**









**Made in Italy**

#### TECHNICAL CARD

<b>net weight (Kg)</b>	93
<b>gross weight (Kg)</b>	111,5
<b>breadth (mm)</b>	820

depth (mm) 450  
height (mm) 572

TECHNICAL CARD

CODE/PICTURES	DESCRIPTION	PRICE/DELIVERY
<b>SI-LF0221A20101010</b>  	<b>TECHNOCHEF - Complete hubs 3 blades not sharpened, Mod.LF0221A20101010</b> Complete hubs 3 blades not sharp for horizontal cutter Cod.KATANA20VV	<b>€ 71,50</b> <i>VAT escluded</i> <b>Shipping to be calculated</b> <b>Delivery</b> from 4 to 9 days
<b>SI-LF0221A20131111</b>  	<b>TECHNOCHEF - Complete hubs 3 toothed blades, Mod.LF0221A20131111</b> Complete hubs 3 serrated blades for horizontal cutter Cod.KATANA20VV	<b>€ 92,05</b> <i>VAT escluded</i> <b>Shipping to be calculated</b> <b>Delivery</b> from 4 to 9 days
<b>SI-LF0221A20232523</b>  	<b>TECHNOCHEF - Complete hubs 3 bevelled blades, Mod.LF0221A20232523</b> Complete hubs 3 bevelled blades for horizontal cutter Cod.KATANA20VV	<b>€ 92,05</b> <i>VAT escluded</i> <b>Shipping to be calculated</b> <b>Delivery</b> from 4 to 9 days
<b>SI-LF022120122100</b>  	<b>TECHNOCHEF - Legs for Horizontal Cutter, Mod.LF022120122100</b> Legs for horizontal cutter Cod.KATANA20VV	<b>€ 458,21</b> <i>VAT escluded</i> <b>Shipping to be calculated</b> <b>Delivery</b> from 4 to 9 days

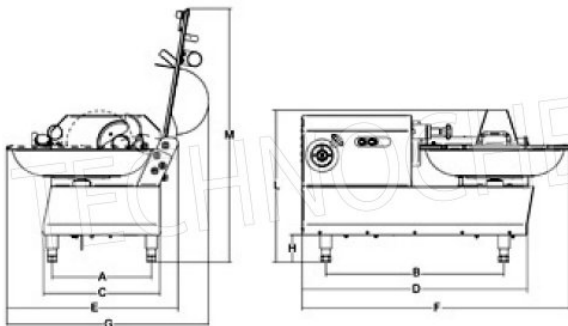

- A mm 390
- B mm 650
- C mm 450
- D mm 820
- E mm 700
- F mm 1013
- G mm 822
- H mm 92
- L mm 572
- M mm 1010